

COMPONENT FUNCTIONAL TEMPLATES: A METHODICAL APPROACH

Daniel R. Abbott¹, Katie Grantham Lough²

¹University of Missouri-Rolla, Department of Mechanical Engineering

²University of Missouri-Rolla, Department of Interdisciplinary Engineering

ABSTRACT

The purpose of this paper is to present and discuss a new design tool, *component functional templates*, that serves as a link between the functional basis and component taxonomy. This link can be used as a starting point when it is difficult for designers, attempting to model a product in terms of functions. Data used to generate the templates was taken from consumer product information stored in the UMR design repository. The primary mathematical tool used to analyze the repository data was principal components analysis (PCA). From the results of the PCA, templates representing common forms of the functional descriptions of components were developed. The result of this work is a limited database set of component functional templates that serve as a design aid.

Keywords: Conceptual design, function-based design

1 INTRODUCTION

In product design, functions are defined as “a description of an operation to be performed by a device or artifact, expressed as the action verb of a function block” [1]. Modeling systems in terms of functions is a common method promoted for design development [2-4]. Forming concepts from a functional perspective allows designers to focus on *what* needs to be accomplished in a given system instead of *how* something should be accomplished. A functional model of any system is comprised of flows and functions. Flows are inputs and outputs of the system. Functions are what happen to the flows as they progress through the system. Describing a system in terms of function allows a designer to explore many solution options, which yields a large number of unique design concepts for the system.

Recent endeavours have been aimed toward bringing greater structure, consistency, and ingenuity to the conceptual modeling design approach [5-8]. Design tools such as the functional basis [5] and component taxonomy [6] independently provide a more methodical approach to the design process; however under certain circumstances, a correlation needs to be drawn between the two, connecting them in a common relationship. Such circumstances include 1) when an experienced designer, who thinks in terms of system components, is using function based design tools, and 2) when a novice designer is learning about various components and the functions they perform. As a wealth of historically related design information built from reverse-engineered products, the UMR design repository [9] serves as an excellent platform from which to build the connecting link between functions and components. This link, component functional templates, will serve the circumstances when components and functions seem disparate notions. Ultimately, by training with these unique component-based functional templates, general system function will be generated by designs without thinking strictly in terms of the components from which the system is comprised of, leading to more innovative and creative design solutions for a broad range of problems.

This paper presents the driving forces behind the component functional template project, as well as the theoretical approach of the template generation. Next, the results are presented along with conclusions about template use and future work.

2 BACKGROUND

2.1 Functional Modeling, Functional Basis, and Component Taxonomy

Several tools provide a firm foundation on which the component functional templates are built. These tools have been developed to accommodate nearly all electro-mechanically related design scenarios that could be used in a conceptual design method known as functional modelling. Otto and Wood's [10] description of a functional model is "the meaningful and compatible combination of subfunctions into an overall function," and in order to create a functional model properly, certain steps must be followed, shown in Figure 1.

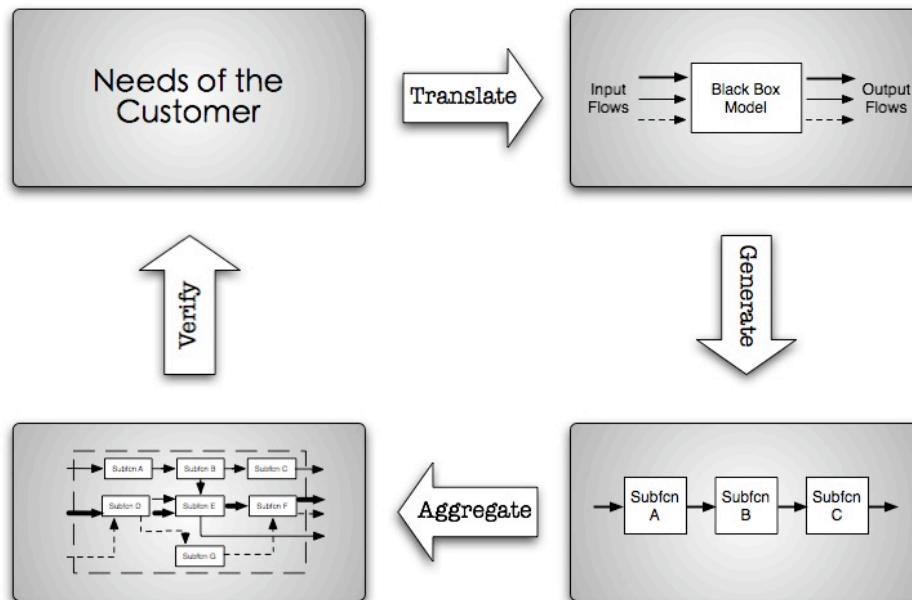

Figure 1. Functional Modeling Standard Operating Procedure

First, the designer determines and translates the needs of the customer to create a black box model, which states the overall function of the system and defines the system inputs and outputs. Next, chains of sub-functions are generated that follow individual flows through the system from where they enter the system to where they exit. Then, the individual flow chains are combined together, merging at similar and/or identical functions and flows, to create the system's functional model. Functions can be added or merged as necessary to account for certain flow behaviors. Lastly, the model is compared against the original customer needs as verification that all requirements have been met.

When natural spoken language is used to describe functions and flows, the resultant functional descriptions may not be consistent between different designers. This discrepancy will lead to results that are meaningless or non-repeatable for other interested parties. To promote effective design communication and avoid references to specific design solutions, the functional basis defines a terminology that can be used in the functional modeling process.

Along with the functional basis, the component taxonomy [11], is used to define a limited set of common electro-mechanical components. Even though the functional basis listing is static, the component taxonomy is not and therefore the database of component functional templates is dynamic as well. This means that as the component taxonomy is modified or grows by adding new components and definitions, the template database will increase proportionately with the taxonomy. This is not a detrimental issue simply because the same process (described in later sections) will be used to generate the templates for any new additions. The goal of the component functional templates is to link these two design ontologies to promote functional design techniques and innovative design solutions.

2.2 Functional Modeling Aids

Team X is a group from the NASA Jet Propulsion Laboratory that designs space missions in a war room type setting with a short turn around time [12]. In an effort to improve the design process within Team X, it was noted that a tool assisting designers to relate functionality with current standard subsystems would prove quite useful in facilitating design solutions [13]. A finite set of specialized, high-level functional templates was created to accommodate the design needs of the members of Team X. Figure 2 is an example of a Team X functional template that represents the functional sequence of a thermal controlling system or sub-system.

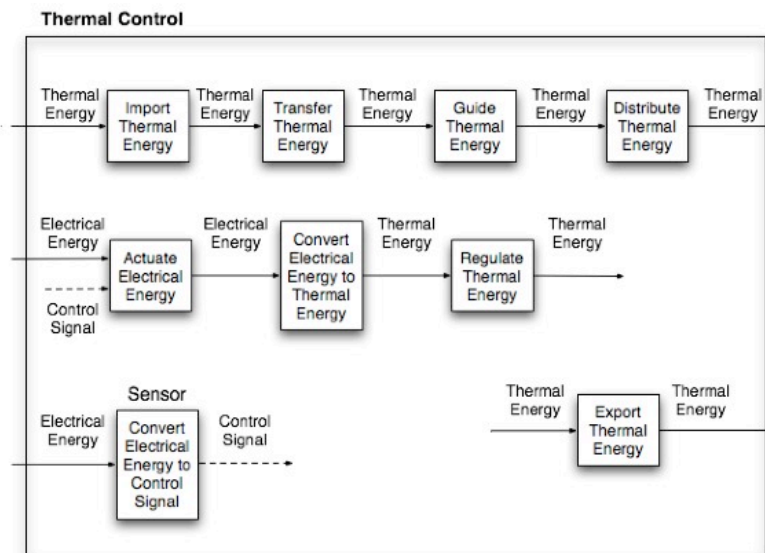

Figure 2. Team X Thermal Control Template

This template, and others similar to it, were meant to be used as a starting point for functional modeling development by system experts whose years of experience lead them to think in terms of design solutions (subsystems or components) rather than system function. The templates improve the incorporation of new techniques, which promote creativity and more innovative solutions through function-based design techniques. However, these space mission templates have been designed with a very specialized field in mind, which limits the scope of designers that benefit from the use of the tool. A database of templates, similar to those of the Team X models, that covers the full spectrum of design will be useful not only to Team X, but also to other design teams whose products may be quite different.

Furthermore, since the initial conception of function structures by Pahl and Beitz [14], current active-learning methods of teaching engineering design in the classroom partially rely on modeling systems or products in terms of function [15]. There have been a number of attempts to develop tools that will aid developers in this process and one such tool, graph grammars [16], has been used to create computer-based tools to quickly generate function structures, but this tool still builds and works strictly from the standpoint of function so that it may be difficult for a beginner to grasp the fundamental ideology that is being presented.

2.3 Principal Components Analysis

The mathematical technique used to generate the component functional templates is Principal Components Analysis (PCA). PCA is a statistical data analysis tool currently being used and researched in other fields including psychology and education [17], quality control [18], chemistry [19], photographic science [20], market research [21], economics [22], and anatomy and biology [23], where it is utilized in several different forms and representations (sometimes confused with factor analysis [24]). PCA statistically represents a large collection of information with a smaller set. Therefore, it is a useful means of analyzing the vast functional representations of engineering products.

PCA is not a new concept to the engineering design field and particularly to the scope of functional design. Function-failure work has been done previously that utilizes PCA derived methods as a means to compress large amounts of information in matrix form while turning due attention to areas of higher risk which then should be evaluated to meet a given standard [25]. In a similar manner, PCA is used to filter through large amounts of data from the design repository and return function information that represents the individual components from the component taxonomy and can be used to build the individual templates.

2.4 UMR Design Repository

The data needed to perform the PCA was taken from the UMR Design Engineering Lab's design repository (function2.basiceng.umn.edu) [26], a free online knowledge-base of searchable design information. The repository stores product information, including failure, materials, functions, components, measurements, etc. The information was gathered through reverse engineering more than 170 consumer products. Design tools are available on the webpage that allow a user to search for desired information which can be returned in matrix form, like the function-component matrix, the design structure matrix, and the product-function matrix. These design tools enable many product design analyses, which promote innovative design solutions.

3.0 THEORETICAL APPROACH

With the functional basis, component taxonomy, principal components analysis, and the UMR design repository, the component functional templates were formulated using a method shown in the Figure 3. Initially, the necessary information is gathered from the repository in matrix form. Then a PCA is performed on the matrices and the results are interpreted to find the relevant functions. Lastly, the functions are combined and organized in such a way that all necessary formatting and function structure is taken care of. These stages are covered in the next sections.

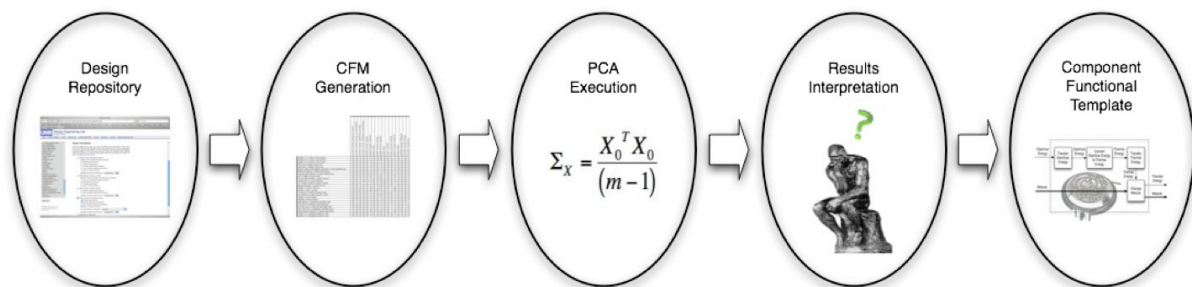

Figure 3. Template Development Progression

3.1 Gathering Design Information

The component functional templates are representative functions for a given component. In order to determine the historical representative functions for each component in the component taxonomy, historic functional representations must be gathered for each component in matrix form from the UMR design repository. While the repository has used many products to derive design information, it is still not fully populated so that some of the information diverges away from a single set of functions. But, as the repository gains momentum and more artefacts are entered, the representative functions will converge to a single set and allow for greater consistency when searching the database. The process involves selecting a component from the taxonomy, i.e. container, and then searching the knowledge base for all records of a container and the functions each separate record of a container performs. This data was queried for the component-function matrix (CFM), which provided the desired function-component relationships in matrix form. A screenshot of the area in the repository that houses the CFM generator is presented in Figure 4. This screenshot displays part of the graphical user interface that allows manipulation of several design tools created for database searching of design information.

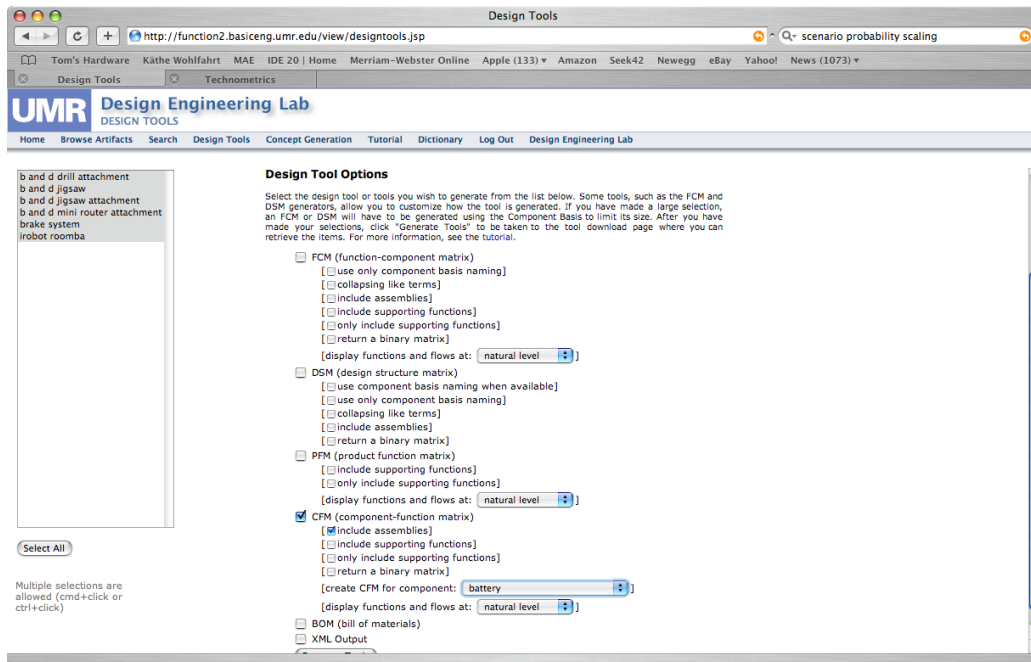

Figure 4. Repository Screenshot of CFM Generator and Available Options

The sample results for the container CFM repository query are shown in Table 1. The rows of the matrix are the individual historic records of the container while the columns are the recorded associated functions of the container. The matrix data is binary where the value 1 indicates that the given container performed the function under which it is listed and a value of 0 indicates that it did not perform that particular function. Using this scheme, a CFM was generated by the repository, searching through all artefacts and sub-assemblies for each component in the component taxonomy. Then, a PCA was executed on each component's CFM to determine its representative functions.

Table 1. Example CFM for the Container Component

	store liquid	convert control to status	distribute thermal	export mixture	export solid	guide liquid	guide solid	import chemical	import liquid	import mixture	import solid	mix electrical to thermal	mix gas to thermal	mix mixture	position solid	separate mixture to gas	separate mixture to solid	separate mixture	store chemical	store mixture	store solid	transfer mechanical
link pads in all-in-one printer	1	0	0	0	0	0	0	0	0	0	0	0	0	0	0	0	0	0	0	0	0	0
link sponge in all-in-one printer	1	0	0	0	0	0	0	0	0	0	0	0	0	0	0	0	0	0	0	0	0	0
paper entry tray in all-in-one printer	0	0	0	0	0	1	0	0	0	0	0	0	0	0	0	0	0	0	0	0	0	0
basket in black 12 cup deluxe coffee	0	0	0	1	0	0	0	0	0	0	0	0	1	1	0	0	1	0	0	0	1	0
carafe glass in black 12 cup deluxe coffee	0	0	1	0	0	0	0	0	0	0	0	0	0	0	0	0	0	0	0	1	0	0
metallic cup in braun coffee grinder	0	0	0	1	0	0	0	0	0	1	0	0	0	0	0	0	0	0	0	0	1	0
cartridge in bugvac	0	0	0	1	0	0	0	0	0	0	0	0	0	0	1	1	0	0	0	0	1	0
fuel tank in datsun truck	1	0	0	0	0	0	0	0	0	0	0	0	0	0	0	0	0	0	0	1	0	0
cup holder in dishwasher	0	0	0	1	1	0	0	0	1	0	0	0	0	0	0	0	0	0	0	1	0	0
dish rack in dishwasher	0	0	0	1	0	0	0	0	1	0	0	0	0	0	0	0	0	0	0	1	0	0
silverware container in dishwasher	0	0	0	1	1	0	0	0	1	0	0	0	0	0	0	0	0	0	0	1	0	0
water tank in durabrand iron	0	0	0	0	0	0	0	0	0	0	0	0	0	0	0	0	0	0	0	1	0	0
gas tank in lawn mower	1	0	0	0	0	0	1	1	0	0	0	0	0	0	0	0	0	0	1	0	0	0
container in snowcone maker	0	0	0	1	0	0	0	0	0	0	0	0	0	0	0	0	0	0	0	0	1	0
staple tray in stapler	0	0	0	0	0	0	0	0	0	0	0	0	0	0	0	0	0	0	0	0	0	1
hopper in tippman paintball gun	0	0	0	0	0	1	0	0	0	1	0	0	0	0	0	0	0	0	0	0	1	0
basket in white 12 cup regular	0	0	0	1	0	0	0	0	0	0	0	1	1	0	0	1	0	0	1	0	0	1
basket in white 4 cup economy coffee	0	0	0	1	0	0	0	0	1	0	0	1	1	0	0	1	0	0	1	0	1	0
carafe glass in white 4 cup economy coffee	0	0	1	0	0	0	0	0	0	0	0	0	0	0	0	0	0	0	0	1	0	0
outer nozzle in zippo lighter	0	1	0	0	0	0	0	0	0	0	1	1	0	0	0	0	0	0	0	0	0	0
sponge in zippo lighter	1	0	0	0	0	0	0	0	0	0	0	0	0	0	0	0	0	0	0	0	0	0
tank in zippo lighter	1	0	0	0	0	1	0	0	0	0	0	0	0	0	0	0	0	0	0	0	0	0

3.2 Results Interpretation

After the PCA has been performed, the results must be interpreted to determine which principal components (PC's) will be helpful in identifying the statistically significant functions to be used in each template. There are many methods of interpretation commonly used to determine the PC cut-off point in a PCA such as Proportion of Trace Explained, Individual Residual Variances, SCREE test, Broken Stick, Average Root, Velicer's method and others [24].

The PCA interpretation method used in this research, because of its ease of use and its inherent ability to keep the number of PC's within a variability range specified by the user, is the commonly used 'Proportion of Trace Explained' method, which is used in many computer software packages [24]. This method applies a percentage limit to the amount of variance from the original data that is to be retained in the remaining PC's so that once the user-defined limit has been reached, the remaining PC's are truncated.

The method used here is a strict user-defined single PC selection so that all necessary functions are presented in the single most significant PC and any other steps that are required to combine multiple PC's are avoided for the sake of simplicity. This particular approach results in a PC cut-off point of 50% such that the PC's from which the functions are taken represent at least a majority of the variability in the original data. Templates whose percentage of data variability passes the stopping threshold fall in this category.

There are 172 defined components in the component taxonomy. Of those 172 components, 79 were not sufficiently represented by the product information in the UMR design repository for this analysis. The remaining ninety-three components make up the pool from which the initial component-function matrices are drawn. Table 2 shows a summary of the PCA execution for the components whose data fit within the >50% range in terms of initial matrix properties and percentile ranking.

Table 2. Category 1 PCA Summary

Component	Initial Matrix Dimensions		Percent of variance represented by:			Summation of PC1, PC2 and PC3
	Number of artifacts	Total functions before compression	PC1	PC2	PC3	
Belt	10	4	56.34%	32.42%	7.72%	96.48%
Carousel	3	7	57.14%	42.86%	0.00%	100.00%
Cushion	6	9	51.58%	26.94%	14.64%	93.16%
Electric Resistor	3	5	70.00%	30.00%	0.00%	100.00%
Heating Element	13	8	52.54%	25.50%	11.15%	89.19%
Hydraulic Piston	3	5	75.00%	25.00%	0.00%	100.00%
Lens	4	7	61.90%	19.05%	19.05%	100.00%
Magnet	3	8	56.25%	43.75%	0.00%	100.00%
Pully	6	3	66.67%	33.33%	0.00%	100.00%
Regulator	3	9	59.62%	40.38%	0.00%	100.00%
Seal	27	8	52.35%	18.62%	10.31%	81.27%
Securer	3	3	78.87%	21.13%	0.00%	100.00%
Sensor	5	13	57.03%	20.29%	14.07%	91.38%
Speaker	4	7	55.56%	22.22%	22.22%	100.00%
Sprocket	4	5	56.90%	33.33%	9.76%	100.00%

The PCA results for fifteen terms from the component taxonomy met the necessary requirements. The eigenvalues for PC1 correlate to a data representant percentage of 51.58% to 78.87%. Values for the percentage of repository data represented by the other principal components, PC2 and PC3, are shown to lend perspective to the great amount of data represented by the first principal component. Another column has been included that shows a summation of the first three PC percentages. This column is conclusive of the fact that for matrices whose elements are highly correlated, the first few principal components will represent the majority of the variance in the original data [27].

Using the components that are included in this category, the relevant functions from the first PC are determined using a SCREE plot, where it determines the cut-off point for the functions included in the first PC.

3.4 Template Generation

Once the historically relevant functions have been identified, the final step in the template generation process is a simple manipulation of the remaining functions into representations of the individual components. When the PCA and results are compiled, the order of functions is not specified but must be determined so that the templates lend themselves to assisting the functional modelling process. This is accomplished by aggregating all of the functions with their common flow interfaces in a logical sequence of events as they are performed by the component. Some functions are related to each other by a common flow. Moreover, some functions may have separate flows, in which case the functions are separated and related solely on the nature of the component.

4.0 EXAMPLE RESULTS AND DISCUSSION

The analysis for the heating element functional template is presented as an illustrative example of the methods described above. This component is one of four whose results were sufficiently represented by the PCA evaluation. Although this component was chosen arbitrarily, it represents the common approach used in development and the results for those four. Following the template generation procedure in Figure 3, the UMR Design Repository was used to gather data on the functions, which were used to model heating elements. This information, in the form of a CFM, is presented in Table 3.

Table 3. CFM for Heating Element Component

	actuate electrical	change mixture	convert electrical to thermal	guide gas	regulate thermal to electrical	supply electrical to biological	transfer electrical	transfer thermal
heating element in b and d rice cooker	0	0	1	0	0	0	1	0
heating element in black 12 cup deluxe coffee	0	1	0	0	0	0	0	1
main circuit board in black 12 cup deluxe coffee	1	0	0	0	0	1	0	0
heating element in black 4 cup regular coffee	0	1	1	0	0	0	0	1
heating coil in cordless kettle	0	1	0	0	0	0	0	0
heating coil in hot air popper	0	0	1	0	1	0	1	0
heating element in mr coffee iced tea maker	0	0	1	0	0	0	1	0
heating element in proctor silex iron	0	0	1	0	0	0	1	0
heating element in slow cooker	0	0	1	0	0	0	1	0
heating coil in supermax hair dryer	0	0	0	1	0	0	1	0
heating coil in westbend electric wok	0	0	1	0	0	0	1	0
heating element in white 12 cup regular	0	1	1	0	0	0	0	1
heating element in white 4 cup economy coffee	0	1	1	0	0	0	0	1

The rows in the CFM are instances of artifacts of the heating element component from the repository, and columns are functions that have been entered into the repository by personnel trained in the methods of functional modelling. For example, the *heating element in black 12 cup deluxe coffee* artefact has the functions *change mixture* and *transfer thermal energy* associated with it, both receiving a value of one. Other functions not related to that particular instance receive a score of zero. The values for PC1, resulting from the computer analysis PCA program, along with the possible functions that are included in the component functional template are displayed in Table 4. Recall from Table 2 that PC1 for this component represents 52.54% of the total variance in the original data.

Table 4. Heating Element PC1 Results with Corresponding Functions

0.0094	actuate electrical
0.5878	change mixture
-0.1545	convert electrical to thermal
-0.0753	guide gas
-0.0969	regulate thermal to electrical
0.0094	supply electrical to biological
-0.5972	transfer electrical
0.5087	transfer thermal

Upon examination of the magnitude of the elements in the first principal component for the heating element, four functions stand out from the output of the PCA. After an engineering interpretation of the magnitudes of the values as the significance of the related functions, a fairly distinct line can be drawn between functions that should be included in the template and functions that should not using the SCREE plot presented in Figure 5. From the plot, it is easy to see that the first three functions will be included in the template and following the suggestion of Cattell and Jaspers, the first “rubble” point in the second grouping is included as well [24]. Included functions for the template of the heating element are the *change mixture*, *transfer electrical energy*, and *transfer thermal energy* functions with relatively larger values which correspond to the three distinct highest points in the plot, along with the next closest point to the cut-off *convert electrical energy to thermal energy*. These functions can then be manipulated to form the component functional template for the heating element found in Figure 6.

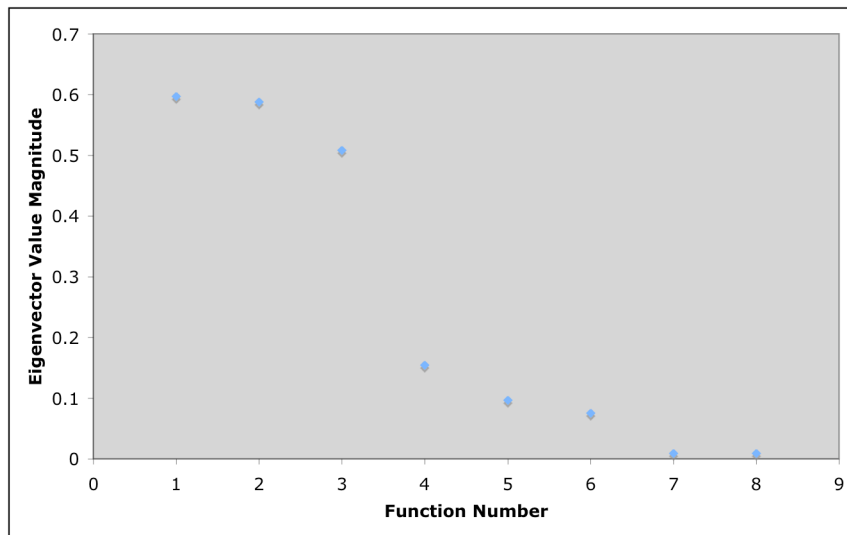

Figure 5. Heating Element SCREE Plot

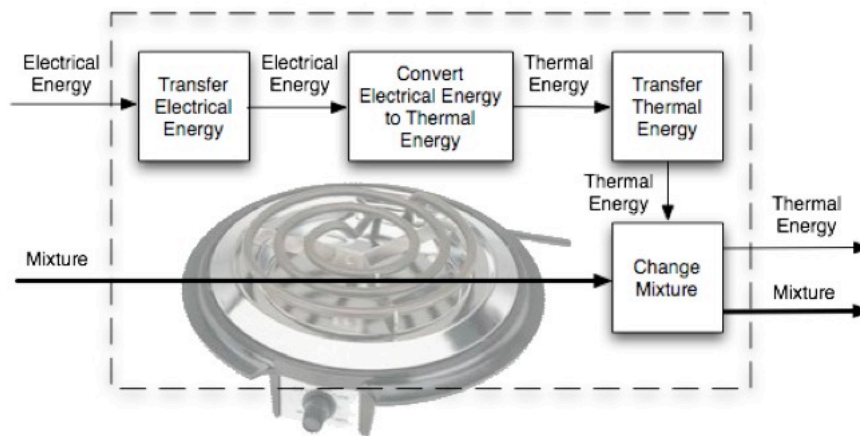

Figure 6. Component Functional Template for Heating Element

Surrounding the functions and flows associated with the heating element component is a dashed line representing the system boundary. It is a common practice to define what functions are included in any individual system or subsystem (or component in this case) apart from other functions in other subsystems and solutions by defining this boundary [2]. The functions determined previously are arranged inside the boundary so that the necessary flows can propagate through the template. In this example, the *electrical energy* and *mixture* flows enter the component from other components or subsystems as relevant functions for the heating element. As the electrical energy is transferred through the heating element it is converted to thermal energy based on the material properties of the coil, which account for the first two functions. Thermal energy is then transferred through the coil and into the mixture that is being heated, prescribed by the third function. As the mixture is heated, the amount of total energy in the mixture is altered resulting in the last function. Note that the change mixture function is where the actual heat transfer takes place between the heating element and the mixture being heated. After the flows exit the component they can then be used as total system output or as input to another component or sub-system.

The results of this component functional template are conclusive of the fact that the functions listed in the template are representative of the main concepts present in a heating element component. For example, a heating element on an electric stove transfers electricity through the length of the element, while the resistance properties of the material convert the electricity to heat. The heat flows through the element and into a pot containing the ingredients of pre-packaged food. As a side effect of gaining more heat, the individual ingredients are converted into an enjoyable meal.

Similar to the heating element, the cushion, seal, and sensor templates have been generated using the same method. These templates are shown in figures 7 through 9.

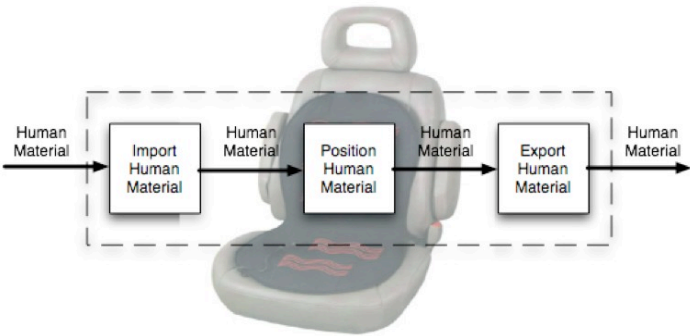

Figure 7. Component Functional Template for Cushion

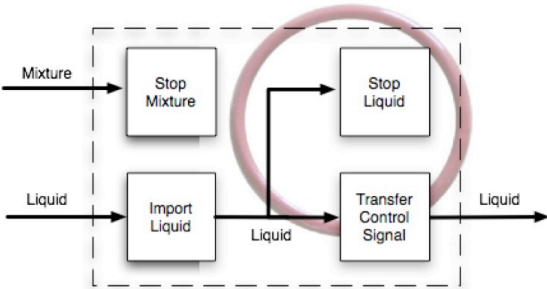

Figure 8. Component Functional Template for Seal

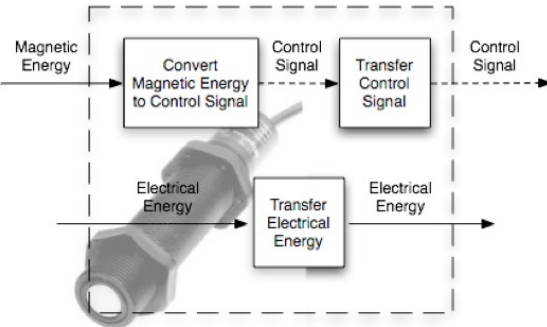

Figure 9. Component Functional Template for Sensor

As the templates are implemented in any beginner setting, they are designed as an introductory tool. When performing the functional modeling process the first few times, the templates will most likely be a necessity for the designer. A good analogy for how the templates work is how an injured person uses a crutch to help build up enough strength until they can walk on their own. But, as more products are analyzed and functional modeling knowledge is gained, the novice can gradually rely less and less on the templates and more the new skills that they have acquired since using the templates. After new students have been shown the templates it is important that other lessons in the functional basis terms and modeling structure follow so that they do not become too dependant on the templates. The templates are also useful for the instructor by providing many examples of proper formatting and structure for students to observe and utilize.

5.0 CONCLUSIONS AND FUTURE WORK

For many designers, young and old, thinking in terms using physical components is a natural course so that as a functional approach to design becomes more common in the design field and education, it is difficult to convert to a new type of thought process. A new historically based functional design tool

that will help these designers learn this new approach more efficiently and effectively, has been developed and presented in this paper. While the templates enable new students to learn in an active learning style by giving them an opportunity to physically build functional models and participate in the classroom, they also give instructors an advantage to presenting new information to the students. This educational aid has been built upon standards and methods that are readily used in the modern field of engineering design.

Future work includes an investigation on the results that fall outside of the 50% boundary category and insufficiently represented functions in other templates as well as PCA validation techniques such as Q-statistic or T^2 methods as suggested by Jackson. To complete the tool and promote the use of new technology, a computer program with a visually appealing graphical user interface will be implemented.

REFERENCES

1. Stone, R. and K. Wood, *Development of a Functional Basis for Design*. Journal of Mechanical Design, 2000. **122**(4): p. 359-370.
2. Cross, N., *Engineering Design Methods: Strategies for Product Design*. Third ed. 2000, England: John Wiley & Sons Ltd. 212.
3. Dominick, P.G., et al., *Tools and Tactics of Design*. 2001, New York: John Wiley & Sons, Inc. 221.
4. Dym, C.L. and P. Little, *Engineering Design: A Project-Based Introduction*. Second ed. 2004, Hoboken, NJ.: John Wiley & Sons Inc. 226.
5. Hirtz, J., et al., *A Functional Basis for Engineering Design: Reconciling and Evolving Previous Efforts*. Research in Engineering Design, 2002. **13**(2): p. 65-82.
6. Kurtoglu, T., et al. *Deriving a Component Basis for Computational Functional Synthesis*. in *International Conference on Engineering Design, ICED'05*. 2005. Melbourne, Australia.
7. Bohm, M. and R. Stone. *Product Design Support: Exploring a Design Repository System*. in *ASME International Mechanical Engineering Congress*. 2004. Anaheim, CA.
8. Vucovich, J., et al. *Concept Generation Algorithms for Repository-Based Early Design*. in *Proceedings of IDETC/CIE 2006*. 2006. Philadelphia, PA: ASME.
9. Bohm, M., R. Stone, and S. Szykman, *Enhancing Virtual Product Representations for Advanced Design Repository Systems*. Journal of Computer and Information Science in Engineering, 2005. **5**(4): p. 360-372.
10. Otto, K. and K. Wood, *Product Design: Techniques in Reverse Engineering, Systematic Design, and New Product Development*. 2001, New York: Prentice-Hall.
11. Greer, J.L., et al. *Enumerating the Component Space: First Steps Toward a Design Naming Convention for Mechanical Parts*. in *ASME Design Engineering Technical Conference, Design Theory and Methodology Conference*. 2003. Chicago, IL.
12. Deutsch, M.-J. and J.S. Nichols, *Advanced Approach to Concept and Design Studies for Space Missions*. Astrophysics and Space Science, 2000. **273**: p. 201-206.
13. Van Wie, M., K. Grantham, and R. Stone. *An Analysis of Risk and Function Information in Early Stage Design*. in *Proceedings of IDETC/CIE 2005*. 2005. Long Beach, CA.
14. Pahl, G. and W. Beitz, *Engineering Design: A Systematic Approach*. Second ed. 1996, London, UK: Springer-Verlag.
15. Abbott, D.R. and K. Grantham Lough. *A Review of Component Functional Templates as an Engineering Design Education Aid*. in *ASEE Annual Conference and Exposition*. 2007. Honolulu, HI: Accepted for publication.
16. Sridharan, P. and M. Campbell. *A Grammar for Function Structures*. in *Proceedings of DETC2004*. 2004. Salt Lake City, UT.
17. Harmon, H.H., *Modern Factor Analysis*. 3rd ed. 1976, Chicago, IL: University of Chicago Press.
18. Jackson, J.E. and R.A. Bradley, *Sequential χ^2 and T^2 -Tests and Their Application to an Acceptance Sampling Problem*. Technometrics, 1961. **3**(4): p. 519-534.
19. Windig, W., *Mixture analysis of spectral data by multivariate methods*. Chemometrics and intelligent laboratory systems, 1988. **4**(3): p. 201-213.

20. Simonds, J.L., *Application of characteristic vector analysis to photographic and optical response data*. J. Optical Soc. Amer., 1963. **53**: p. 968-974.
21. Arrington, C.E., W. Hillison, and R.E. Jensen, *An Application of Analytical Hierarchy Process to Model Expert Judgements on Analytical Review Procedures*. Journal of Accounting Research, 1984. **22**(1): p. 298-312.
22. Bartlett, M.S., *Statistical estimation of supply and demand relations*. Econometrica, 1948. **16**: p. 323-329.
23. Van Gerven, D.P. and G.B. Oakland, *Univariate and multivariate statistical model in the analysis of human sexual dimorphism*. Statistician, 1973. **22**: p. 256-268.
24. Jackson, J.E., *A User's Guide to Principal Components*. 2003, Hoboken, NJ: John Wiley & Sons, Inc. 569.
25. Roberts, R., R. Stone, and I. Tumer. *Deriving Function-Failure Similarity Information for Failure-Free Rotorcraft Component Design*. in *Proceedings of DETC'02*. 2002. Montreal, Canada.
26. Bohm, M., R. Stone, and T. Simpson. *Introduction of a Data Schema: The Inner Workings of a Design Repository*. in *Proceedings of IDETC/CIE 2006*. 2006. Philadelphia, PA: ASME.
27. Jolliffe, I.T., *Principal Component Analysis*. 2nd ed. Springer Series in Statistics. 2002, New York, NY: Springer-Verlang New York Inc.